



www.my-ray.com

Plant - Via Bicocca, 14/c - 40026 Imola - Bo (Italy) tel. +39 0542 653441 - fax +39 0542 653555

Headquarters - Cefla s.c. Via Selice Provinciale, 23/a - 40026 Imola - Bo (Italy) tel. +39 0542 653111 - fax +39 0542 653344

Cefla North America, Inc. 6125 Harris Technology Blvd. Charlotte, NC 28269 - U.S.A. Toll Free: (+1) 800.416.3078 Fax: (+1) 704.631.4609

Data subject to changes without prior notice. 04/2019 M9PROGB181500
According to the relevant regulations, in the extra-EU areas, some products and/or characteristics might have different availability and specifications. Please contact your local supplier. The images shown are for illustration purposes only. The images shown are for illustration purposes only.



Hyperion X9 pro
Professional 3-in-1
full-touch imaging system



The 3-in-1 system designed for the future.

Hyperion X9 pro offers the new 3D technology, cephalometric projections and a wide range of 2D examinations.

2D/3D high-definition imaging and cutting-edge technology for a complete, upgradable, and small-sized platform. Hyperion X9 pro meets every diagnostic requirement by easily integrating into the work flow and guaranteeing maximum comfort for both patient and operator.

SuperHD quality images that allow the doctor to make a correct diagnosis, thanks to easy and completely guided procedures. Full accessibility and user-friendliness with the innovative full-touch control panel and fast Face To Face positioning which guarantees maximum comfort to both patient and operator. The wide scalability and modularity of Hyperion X9 pro allows to change the setting according to your needs, upgrading from a basic to an advanced version in a simple and cost-effective manner.

Powerful, reliable, easy.

- Configurable and modular
- Image technology and quality
- Optimal user experience
- Comfort and ergonomics
- Full connectivity

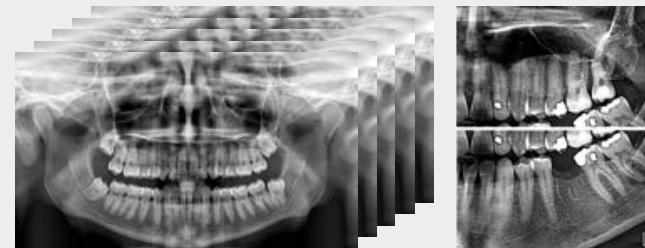

MULTIPAN (MRT).

Multi-layer panoramic x-ray with constant magnification and a wide range of 2D programmes to meet even the most specialist requirements.

Scans with an extremely high level of details, high orthogonality and specific trajectories to study dentition, temporomandibular joints and maxillary sinuses. Automatic optimisation of dose and acquisition time for adults and children.



FULL CEPH.

The improved teleradiography system of Hyperion X9 pro offers programmes for every diagnostic requirement. High-quality images, extremely fast scan times and reduced irradiated dose: the very best of cephalometric technology with the smallest operational footprint available on the market.

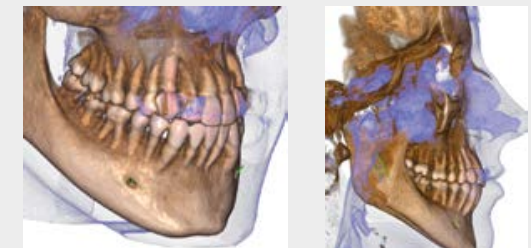

SUPERHD CB3D.

360-degree 3D imaging with low-dose and ultrafast high-resolution scans: 75µm on the entire dentition and up to 68µm by using the exclusive XF (eXtended Function) feature together with dedicated FOV developed to obtain the best results at all times. Complete dental diagnosis, specific examinations to study the inner ear, assess the upper airways and for ENT applications.

Innovation, power and versatility.

Thanks to its functional and versatile features, Hyperion X9 pro offers full configuration to perfectly suit all your diagnostic requirements.

Maximum flexibility for your diagnoses.

Hyperion X9 pro is fully configurable and its modular and scalable design makes it possible to transition from a basic to a more advanced version in an easy and cost-effective manner. An extraordinary platform that adapts to the needs of your dental practice thanks to the 2D PAN/CEPH sensor that can be easily relocated and to the reversible teleradiographic arm which can be installed on both sides.

The most compact 3-in-1 hybrid system available on the market for high-quality 2D and 3D examinations.

Versatile power.

- Easily upgradable to every configuration
- Reversible CEPH arm
- Relocatable 2D sensor or two dedicated sensors for PAN and CEPH
- The most compact 3-in-1 system



Exceed every expectation.

The extraordinary details of 3D imaging for your high-resolution examinations.

3D imaging takes diagnoses to a higher level, an essential dimension to give more value to your job. Thanks to a wide range of fields of view (from 4 x 4 up to 13 x 16 cm), Hyperion X9 pro is the ideal tool to meet all your clinical needs, from the analysis of tooth structures to the examinations of temporomandibular joints and ENT applications.

3D Empowerment.

- Multi FOV from 4 x 4 to 13 x 16 cm
- Upgraded generator
- Extremely high resolution (up to 68µm)
- Fast CB3D scan (up to 3.4s)
- Low dose

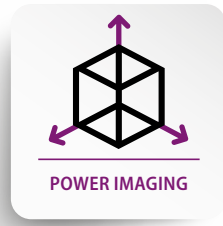
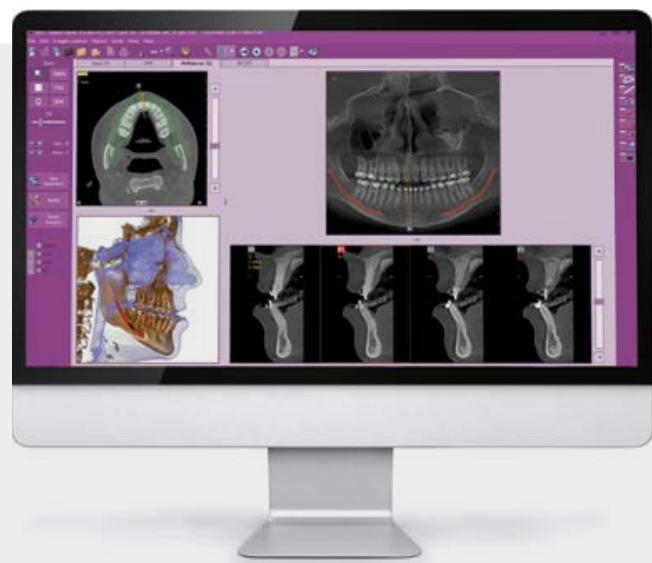

DOUBLE DENTAL ARCH SCAN AT 75 µm

FOV with a 10 cm diameter, essential to include also the complete roots of impacted third molars and height up to 10cm. Thanks to the exceptional 75µm resolution, with one single acquisition Hyperion X9 pro makes available to you the entire dentition and the surrounding bone structures. The perfect tool to plan multiple implants, also with the use of surgical guides.

FULL AIRWAYS

The 13 x 16 cm FOV captures the complete upper airways in one single examination. Detailed view of the entire dentition, maxillary sinuses and upper airways, so as to clearly identify possible signs of narrowing and correctly diagnose obstructive sleep apnea syndromes (OSAS).

Reach a new level.

Simple and versatile, but also technologically advanced. Hyperion X9 pro integrates extraordinary innovations that bring the future of 3D diagnostics to your clinic.

The very best of technological evolution for 3D diagnostics in your clinic. Hyperion X9 pro is equipped with an upgraded generator designed to give you optimal results in quick time and with a 3D sensor that delivers high-quality images with low irradiated dose. This next-generation technology, combined with optimised scanning protocols, makes it possible to achieve an extraordinary 68µm resolution.

Perfection in details.

- New upgraded generator
- High-sensitivity 3D sensor
- 360-degree scan



FAST 360-DEGREE SCAN

The main advantage of 360-degree scanning is a considerable reduction of artifacts. Hyperion X9 pro combines this type of acquisition with extremely fast execution times. In just 14" it is indeed possible to carry out complete high-resolution examinations at low X-ray doses: excellent quality, detailed particulars, fast diagnosis.



UPGRADED GENERATOR

The constant potential generator, equipped with a focal spot of just 0.5mm, optimises exposure thanks to the pulsed emission technology thereby ensuring the best results with the lowest irradiated dose.



WIDE 3D CONTROL PANEL

The technologically-advanced 3D control panel stands out for its exceptional sensitivity which allows for extremely detailed examinations. Volumes of complete dentition and upper airways in SuperHD quality for accurate diagnoses at all times.

Multiple FOV

SuperHD diagnosis.

MultiFOV and high resolution: wonderful 3D images for all your radiology needs.

A wide range of FOV to meet any clinical requirement: from implantology to the measurement of airway volumes, from endodontics to oral surgery. All the FOV, from the smallest to the largest, are available in three execution modes to suit every need. Just a few steps are required to identify the most suitable setting according to the selected anatomical region. The innovative selection between the three dedicated modes allows the operator to carry out examinations based on the actual diagnostic needs and with extreme ease:

QuickScan Faster low-dose scans for post-surgery follow-ups and macro-structure analyses.

Standard mode Primary diagnosis and treatment planning. The best balance between dose and quality.

SuperHD Exceptional level of detail, without compromise. Ideal for the analysis of micro-structures.

Smart CB3D.

- MultiFOV
- 3 protocols each FOV
- Dentistry and otorhinolaryngology
- Implantology, orthodontia, gnathology, endodontics
- Ear, nose, throat and sinuses

ENT

ENT EXAMINATIONS

- Ear: 7 x 6 cm (XF)
- Nose and maxillary sinuses: 13 x 8 cm
- Mouth and Throat: 13 x 10 cm
- Complete upper airways: 13 x 16 cm

DENT

DENTAL EXAMINATIONS

ADVANCED

- Dentition up to the anterior teeth: 13 x 16 cm
- Ascending mandibular rami: 13 x 10 cm
- Zygomatic arches and sinuses: 13 x 8 cm
- Maxillary sinuses: 10 x 10 cm
- Temporomandibular joint: 7 x 6 cm (XF)
- Teeth: 4 x 4 cm (XF)

BASIC

- Complete dentition, adult: 10 x 8 cm
- Single dental arch, adult: 10 x 6 cm
- Complete dentition, child: 8 x 8 cm
- Single dental arch, child: 8 x 6 cm
- Hemiarch or anterior dentition: 6 x 6 cm



FOV 6 X 6 CM

6 cm height to view sectors along the dental arch. Scan only the area you are interested in: hemiarches or frontal zones, without excluding the occlusal area or the base of the mandible, thereby reducing the patient's dose to the patients.



FOV 4 X 4 CM

The highest resolution available on the market at your disposal. Captures every detail up to 68µm and brings your work to a higher level. Possibility to perform very low-dose analyses in ultrafast scanning (only 3.6s) for easier 3D morphological studies in real time.



FOV 10 X 8 CM

With one single acquisition, Hyperion X9 pro shows the entire dentition of adult patients, including the roots of impacted third molars, in very low-dose with 6.4s ultrafast scanning or in high resolution up to 75µm.



FOV 13 X 16 CM

Widen your view, broaden your diagnosis: from the inferior and superior dental arch to the maxillary and frontal sinuses. Get complete information in one volume that includes upper airways, nose and throat. Obtain a more thorough assessment of the case.

3D. Clinical cases

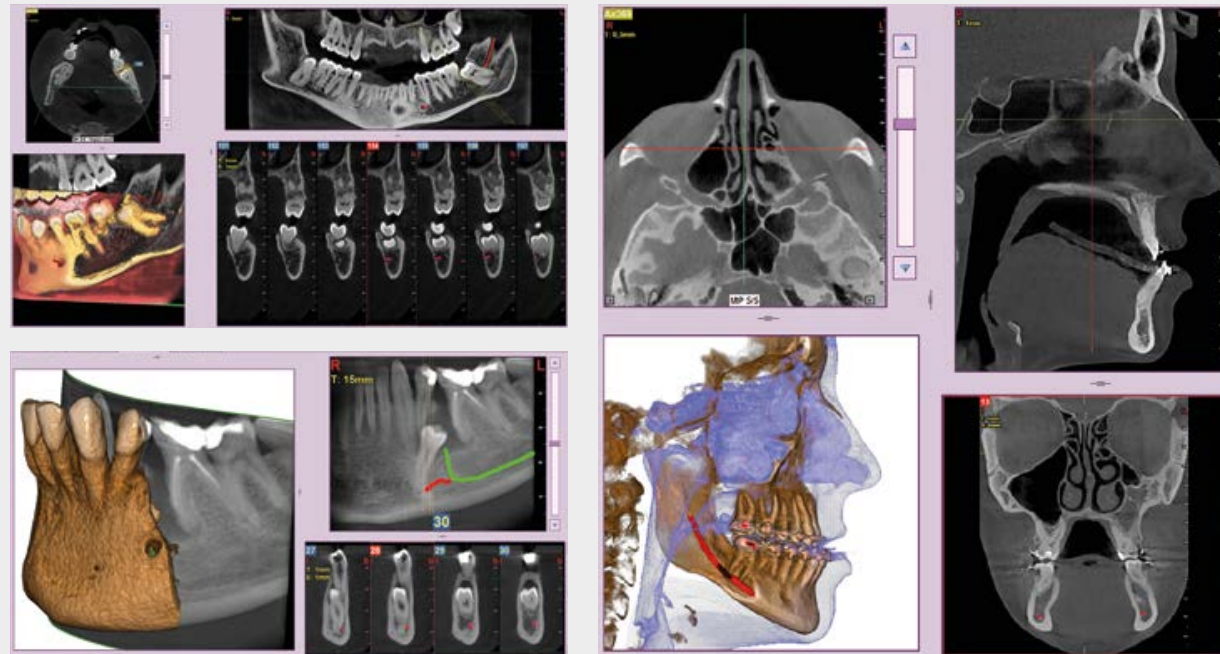

Orthodontic applications

FOVs with a 10 cm diameter are essential for the study of impacted third molars because, in an adult of medium build, the distance between the third molars on the left and right, including the respective roots, the alveolar process and the surrounding bone, is at least 9 cm. Reduced fields of view are useful when analysing impacted or supernumerary teeth in order to restrain the dose to the region of interest. For a correct treatment planning it is indeed crucial to determine the actual position (vestibular or palatal). This is only possible with a 3D analysis, even at a very low dose, with the QuickScan protocol. The complete 13 x 16 cm field of view allows for an accurate assessment of the upper airways, which is often useful to complete the investigation for an orthodontic treatment that does not neglect ENT problems.

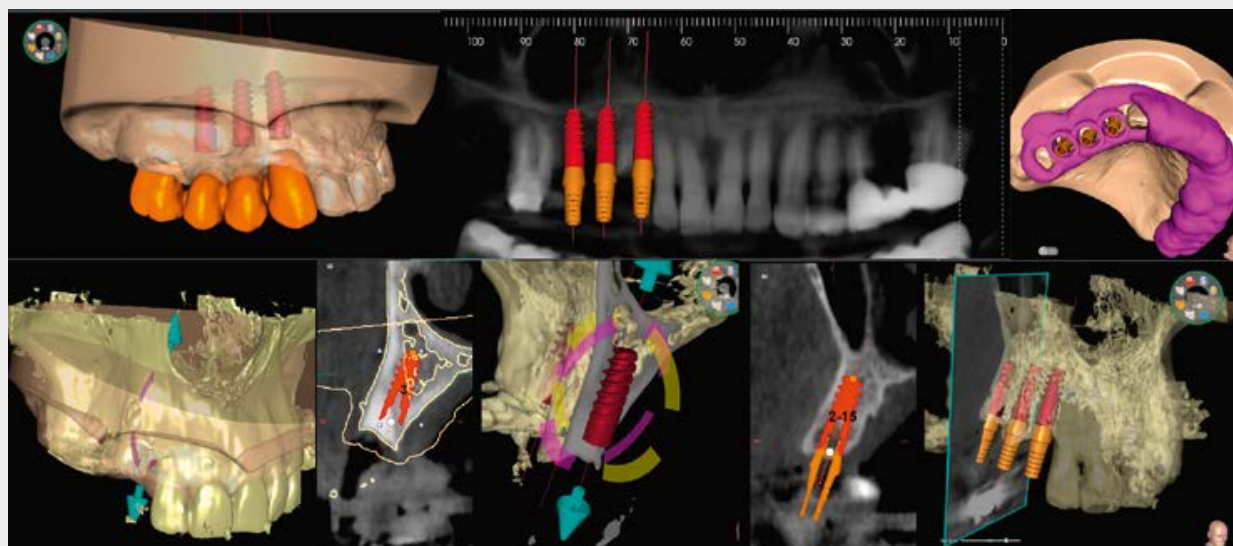

Advanced implant planning

Position the equipment directly on the 3D model, combine it with the STL data from intraoral scanners and define the final prosthetic project. With the advanced implant planning tools you will be able to operate safely thanks to accurate information on the amount of bone and the distance from the surrounding anatomical structures, such as the mandibular canal, defining a minimum safety distance.

Volume analysis

The software feature for the assessment of the sinus floor lift volume allows for an early planning of the intervention and for a perfectly safe procedure. It is also possible to trace lines directly on the virtual model of the patient thereby assessing morphological relations on the 3D rendering.

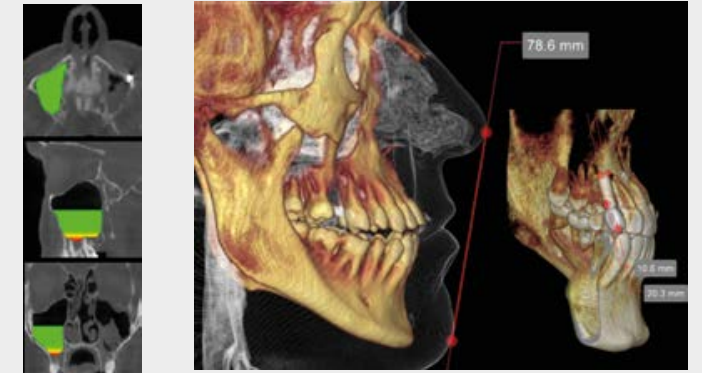

Assessment of zygomatic implants

Volumes with 13 x 8 cm or 13 x 10 cm FOV are the perfect tool for zygomatic implant planning as the 13cm diameter is the only one that makes it possible to include the entire zygomatic arch, without cuts.

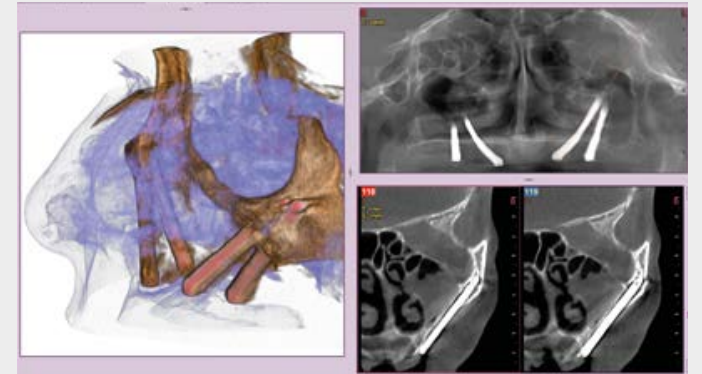

Endodontic examination

Treatment of the mandibular canal and identification of micro-fractures and root resorption: the exceptional 68 µm resolution, unique to Hyperion X9 pro, brings your diagnoses to a higher level.



View of the inner and middle ear

The dedicated 7 x 6 cm FOV at 68 µm provides a clear and detailed view of all the structures in the inner and middle ear, such as the round window, the semicircular canal and the ossicular chain.

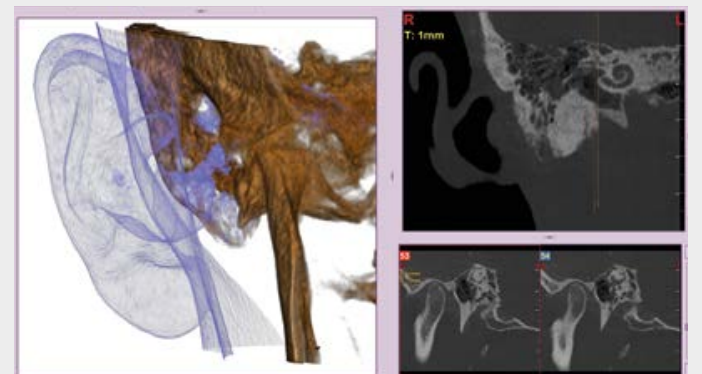

Capture every detail.

High-definition images, extremely sharp details, upgraded MultiPAN system for maximum results in every situation.

The dedicated and easily relocatable CMOS sensor (next-generation CsI) generates clear, homogeneous and high-definition images while keeping low the irradiated dose. Panoramic x-ray with high-orthogonality reduces the overlapping of adjacent teeth and shows the structures to be examined in a clear and distinct manner. The wide range of focal layers makes it possible to capture detailed images along the entire dental arch. In order to optimise scan times and patient's exposure, each type of image is acquired with a dedicated trajectory and collimation.

Exact details, maximum performance.

- Dedicated 2D sensor
- High orthogonality
- Variable collimation
- Wide range of focal layers
- PiE (Panoramic Image Enhancer) filters



HD MULTIPAN.
Hyperion X9 pro provides clear and detailed panoramic images at all times. In one single scan, with the same exposure time and irradiated dose of a traditional panoramic x-ray, the unique MultiPAN feature generates 5 different focal layers to choose the one that best suits your diagnostic needs.

ADVANCED KINEMATICS.
Hyperion X9 pro provides you with the most advanced imaging technology. It is indeed equipped with perfectly synchronised kinematics featuring one rotary movement and two simultaneous translatory movements that ensure constant magnification in all projections. The scans are always in focus thanks to the optimised focal trough which follows the patient's morphology.



• Hyperion X9 pro	• High-end competitor
Constant magnification	Uneven magnification
1 rotary movement and 2 simultaneous translatory movements	1 rotary movement and only 1 simultaneous translatory movement



Discover a world of examinations.

Optimized 2D programmes for unparalleled panoramic and cephalometric images.

Hyperion X9 pro provides optimal 2D trajectories for unparalleled images. Besides standard panoramic x-ray, you can perform orthogonal dentition projections and bitewing exposures focused on dental crowns. It is possible to segment the dentition area and limit the scanning zone to the region of interest in order to keep low the irradiated dose. The examinations of the temporomandibular joints are available both in postero-anterior and latero-lateral projections, with acquisitions also from multiple angles. Broad and accurate investigations, including the maxillary sinuses, make it possible to study the upper airways and better plan sinus lift surgeries. The QuickPAN feature allows to minimise scan times for faster and more comfortable examinations.

Wide diagnostic range.

- HD orthogonal panoramic X-ray
- QuickPAN
- Segmentation of the areas of interest
- SuperHD bitewing
- Multi-angle TMJs

PAN

PANORAMIC EXAMINATIONS

- HD panoramic X-ray and QuickPAN
- Full and reduced panoramic X-ray for children
- Orthogonal projection for the whole dentition (reduces the overlapping of dental crowns)
- Segments of panoramic X-ray and dentition with optimised dedicated projections
- Bitewing exposures in 4 segments limited to the crowns, so as to highlight interproximal cavities

TMJ

TMJ EXAMINATIONS (OPEN OR CLOSED MOUTH)

- Latero-lateral projection of both TMJs
- Postero-anterior projection of both TMJs
- Latero-lateral projection from multiple angles (x3) of a single TMJ
- Postero-anterior projection from multiple angles (x3) of a single TMJ

SIN

EXAMINATION OF THE MAXILLARY SINUSES

- Frontal or left/right side view of the maxillary sinuses



Optimise every perspective.

High performance, ultrafast scans and a complete selection of cephalometric projections. Choose the examination that best suits your diagnostic requirements.

Hyperion X9 pro modular platform allows to add the teleradiography module at any time and with extreme ease. Its cephalometric arm is a true engineering masterpiece.

Besides being the most compact system on the market, it is also reversible: it can be mounted either on the left or on the right, and, if space requirements change, Hyperion X9 pro CEPH changes with you.

The relocatable latest-generation PAN/CEPH sensor, combined with an upgraded generator, guarantees excellent performance in any application. Select the exam that best suits your diagnostic needs choosing between ultrafast or high-quality scan.

SuperHD quality.

- Minimum bulk
- Ultra-rapid scan
- Variable field of view and FULL CEPH positioning
- Relocatable PAN/CEPH sensor
- Double sensor available

CEPH

TELERADIOGRAPHIC EXAMINATIONS

- Latero-lateral projection with selectable scan length
- Paediatric latero-lateral projection with reduced height, short scan and low dose
- FULL CEPH projection with reduced thyroid exposure and inclusion of skullcap in children
- Antero-posterior or postero-anterior projection
- Submento-vertex (SMV) projection, including Waters' and reverse Towne views
- Carpus projection



SMART COLLIMATION

Thanks to the patented primary servo-controlled collimator, it is possible to select the exact area to expose to the X-rays. The patent-pending secondary collimator for teleradiography projections is integrated into the rotating module and allows for an easy access with minimum footprint.

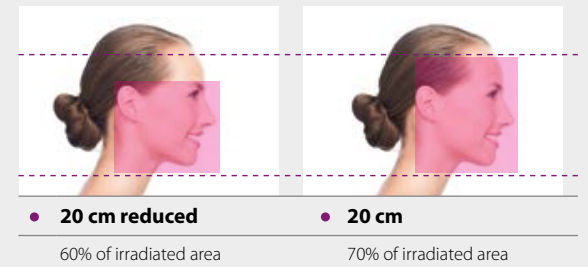

• 20 cm reduced

• 20 cm

FULL CEPH

Hyperion X9 pro adapts perfectly to the examination of children and adult patients. In particular, the FULL CEPH positioning for children reduces the exposure of the thyroid and avoids contact between the sensor and the shoulders. Hence the operator can include, when possible, the skullcap.



• 30 cm reduced

• 30 cm

2D. Clinical cases



1.

Dental panoramic radiographs

1. Orthogonal panoramic X-ray: minimises the overlapping of adjacent teeth and provides better periodontal analysis.

2. Fast panoramic X-ray: low dose and reduced scan time, perfect for primary investigations, follow-ups or uncooperative patients.

3. Child panoramic X-ray: limited exposure and optimised parameters for fast paediatric examinations.

4. Complete dentition divided into quadrants: localised investigations with selectable segmentation to limit the irradiated dose.

5. Bitewing projections limited to crowns: high resolution and low dose, a comfortable alternative to intraoral imaging, appreciated by patients with a strong gag reflex.



2.



3.



4.

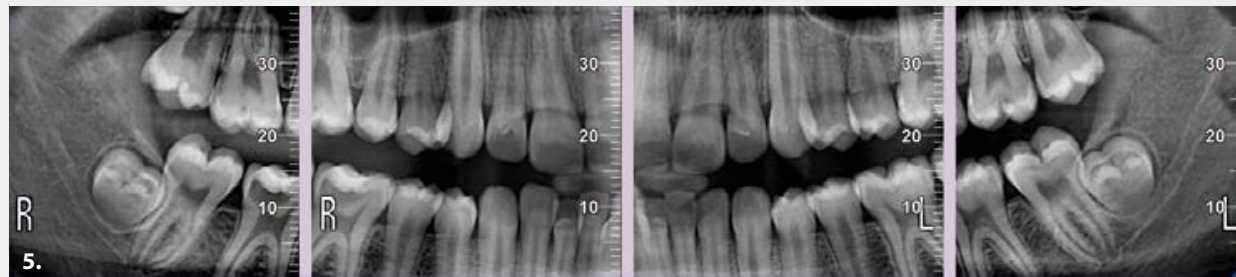

5.

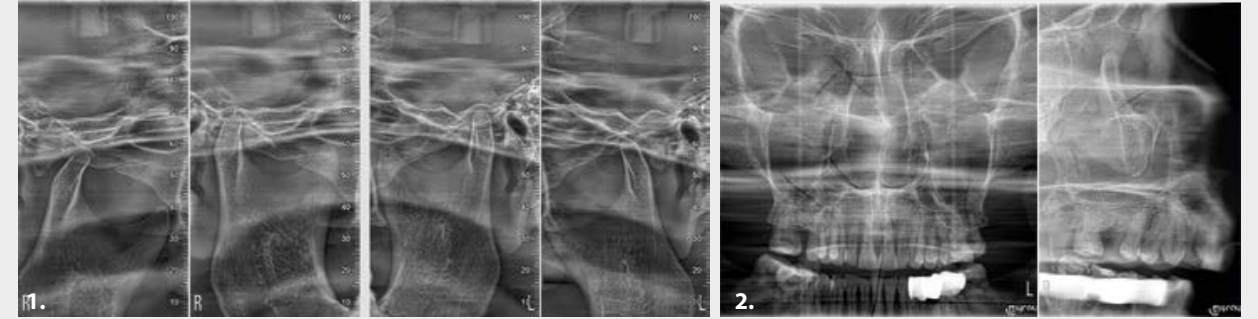

Extraoral tomography

1. Temporomandibular joints: right and left, with open or closed mouth, and in latero-lateral and postero-anterior projections with multi-angle acquisitions.

2. Maxillary sinuses: frontal or left/side view, optimised trajectory.



1.

Teleradiography

1. Latero-Lateral: with bony structures and soft tissue profile, essential for cephalometric studie.

2. Antero-Posterior: to determine asymmetries and malocclusions for a correct treatment.

3. Submento-vertex: for the analysis of nasal cavities, ethmoidal air cells and sphenoidal sinuses.

4. Carpus: for residual growth assessment, possible with dedicated support.

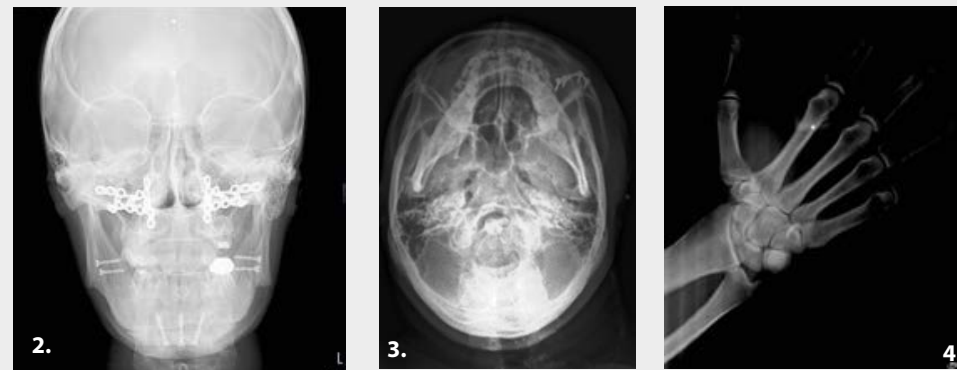

2.

3.

4.

Optimised work flow.

Hyperion X9 pro optimises your work, adapts to your needs and allows to focus on what's really important: your diagnoses.

Hyperion X9 pro provides advanced features and tools to improve your work flow. The user-friendly interface guides the operator step by step throughout the entire exam preparation and acquisition process.

The equipment and the 2D image display can be managed through the on-board full-touch control panel, from the virtual control panel or through iPad*-specific applications, thereby providing maximum versatility.

The exclusive Morphology Recognition Technology (MRT) allows the operator to obtain clear and defined images without manually setting the exposure parameters, since they are automatically adapted to the patient's anatomical features. Thanks to the MultiPan acquisition and to the unique Focus-Free feature, the device automatically returns the best focal layer according to the dental arch morphology.

Improve your work.

- MRT technology
- Multi-platform control panel
- Guided work flow
- Focus-Free PAN
- 3D Free-FOV positioning



IPAD* CONTROL

Hyperion X9 pro is equipped with a user-friendly interface, also available in the iPad*-specific application, for an easy and intuitive control. In few simple steps you can choose and set up the most appropriate exam based on the clinical and anatomical relevance.



PC INTERFACE

The multi-platform control panel gives you easy and immediate access to all the device features. The interface guides you step by step, from the exam selection to its preparation, with FOV guided positioning. The result is easier, faster and more effective examinations.



FULL-TOUCH 10" CONTROL PANEL

User-friendly graphics and direct controls make your work easier, providing patients with a more relaxing experience. Hyperion X9 pro is characterised by the simplicity of use and the rapidity of procedures, such as the possibility to choose predetermined programmes directly from the homepage. The control panel interface provides precise instructions on the patient's positioning depending on the selected protocol.

* must not be used for primary diagnosis.

Technology at the service of well-being.

Hyperion X9 pro allows you to offer your patients the best conditions for effective examinations in a serene and cooperative environment.

Fast scans, low X-ray dose protocols and ergonomic positions: the best ingredients for your patient's comfort and well-being. Hyperion X9 pro always offers acquisition procedures that guarantee maximum accessibility and minimum permanence inside the equipment, thereby simplifying its use with children or patients with motor disabilities. Through the iRYS Viewer app for iPad*, you can also share every step of the treatment with your patient in a clear, intuitive and easy-to-understand manner. A greater involvement of the patient leads to maximum cooperation and trust in the proposed treatment.

Best care.

- Ergonomic positioning
- Fast scan
- Low dose
- Fast sharing



GUIDED AND EFFECTIVE POSITIONING

The positioning is fast and accurate thanks to an alignment system with 4 laser beams projected directly on the patient's face and to the state-of-the-art ergonomic head support unit equipped with 7 fixing points for maximum stability during scanning. The Face to Face positioning guarantees maximum freedom of movement and the patient's comfort.



SERVO-CONTROLLED SYSTEM

Through the Scout View system it is possible to centre the volume on the area of interest, while the patient can remain in the same comfortable position. From the PC, the operator can view the two images (sagittal and frontal) at very low irradiation and accurately modify the scanning area letting the equipment, supplied with servo-assisted movements, find the correct position. This procedure eliminates the risk of having to repeat the examination.

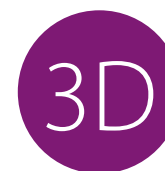

QUICKSCAN
3,6 - 6,4s



QUICKPAN 6s
QUICKCEPH 3,3s

QUICK LOW-DOSE SCAN

Thanks to advanced QuickScan protocols, available for both 2D examinations and 3D acquisitions, it is possible to obtain acceptable images with lower doses as compared to a standard acquisition. These protocols are the ideal tool for post-surgery check-ups and for the identification of any macro-structures (such as impacted teeth or dental agenesis).

* must not be used for primary diagnosis.

Advanced, reliable, iRYS.

The best all-in-one software platform for 2D and 3D imaging.

A state-of-the-art tool equipped with a complete ecosystem of features to view, process and share examinations directly from the dedicated workstation, with the computers of the dental practice and with the iRYS Viewer* application available for iPad*. With one click you can send 2D images and 3D volumes to the management software of the practice or to advanced planning systems (guided implantology, cephalometric tracing, etc.). You can share the examinations with your patients by giving them the viewing programme (Viewer) directly on CD, DVD or USB flash drive. iRYS, the platform that meets all your diagnostic requirements.

A true evolution.

- Multi-desktop 2D/3D
- Implant simulation
- Compatibility with third parties' software
- Sharing with 2D and 3D image viewer
- iRYS Viewer for iPad*

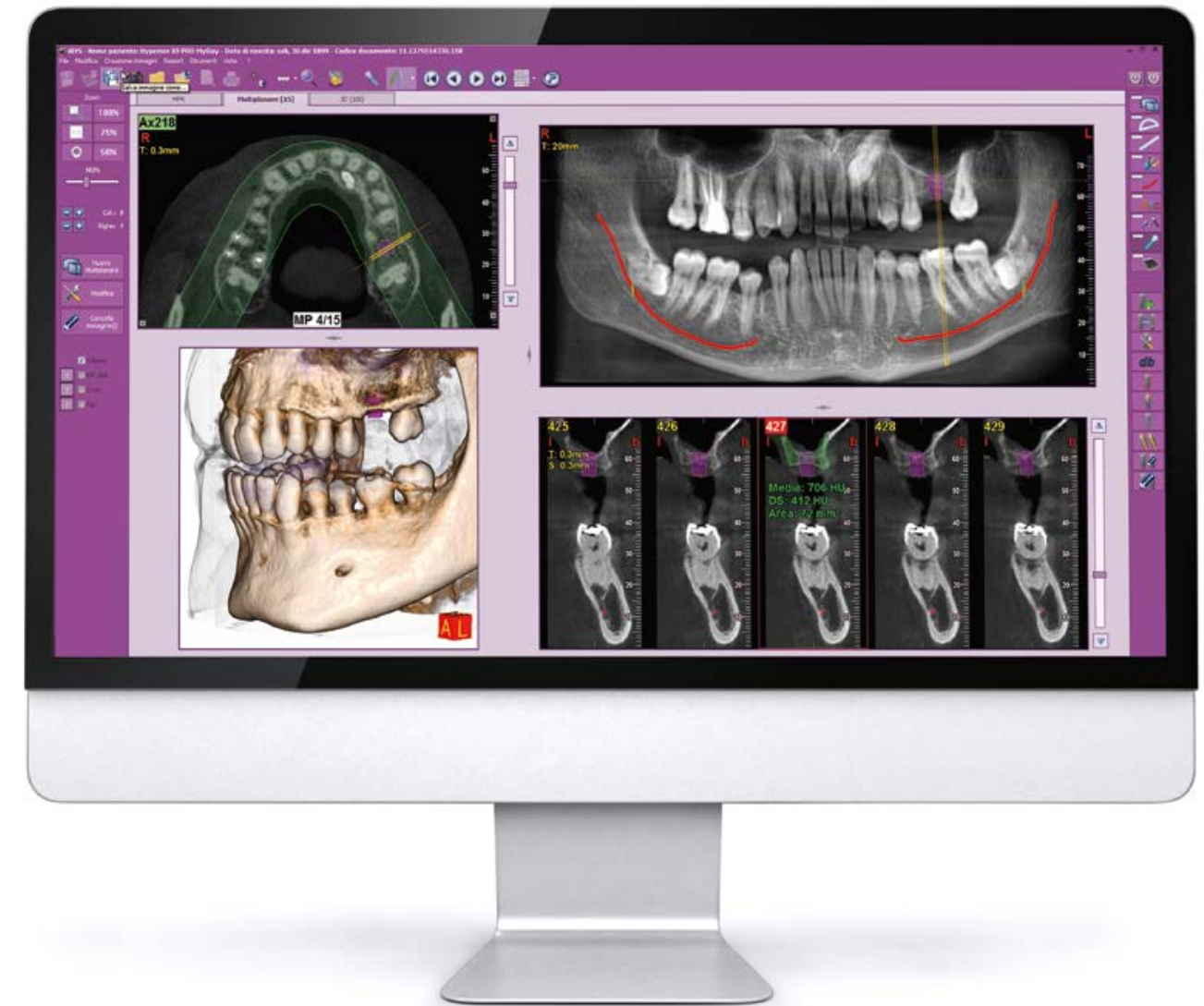

PRELOADED IMPLANT LIBRARIES

iRYS facilitates the selection and positioning of implants chosen among those contained in its extended library. It is also possible to change them or add new ones in just a few simple steps.

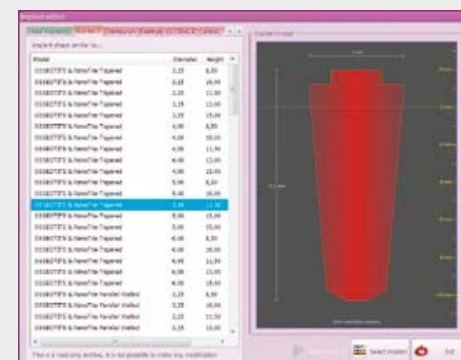

MULTI-DESKTOP 3D/2D

One software to handle 2D and 3D images. The Multi-Desktop system allows for rapid browsing the different 2D and 3D views, with realistic rendering and multipanoramic analysis. Everything you need to carry out high quality diagnoses and communicate quickly with the patient.

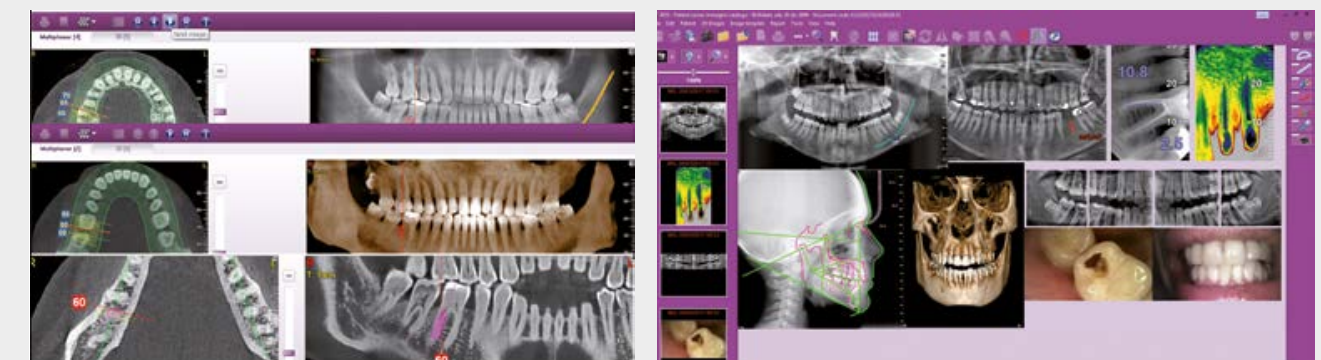

* must not be used for primary diagnosis.

A complete set of tool for your diagnoses.

Simple and efficient diagnosis and planning thanks to the best protocols and the iRYS software filters.

Being an advanced and reliable platform, iRYS provides you with a set of tools for diagnosis and treatment planning that delivers maximum performance at all times. Among them, the exclusive filters to improve image definition and detail level, as well as the features to assess bone quality and analyze airway volume.

Great diagnostic tools.

- Evolved image filters
- PiE (Panoramic image Enhancer)
- Bone quality assessment
- Airway volume evaluation

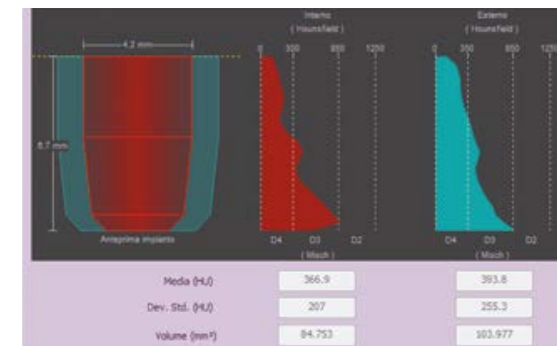

BONE QUALITY ASSESSMENT

To better plan surgeries, post-surgery progress and recovery times, take advantage of the advanced iRYS feature for bone quality assessment (Misch scale), which provides information on the implant site and surrounding anatomical structures.

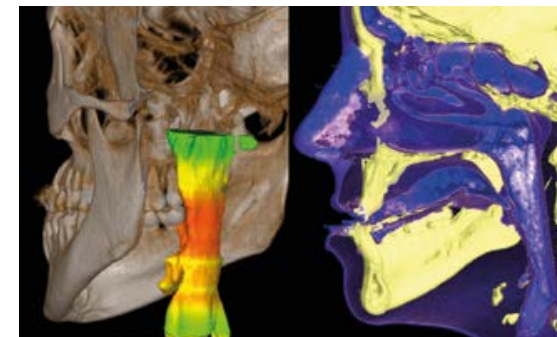

AIRWAY VOLUME

iRYS allows to evaluate the upper airways volume in order to investigate possible disorders in the ENT district. This feature is also particularly useful to plan sinus lift surgery in the event of zygomatic implants or for the preliminary assessment of obstructive sleep apnea (OSA).



2D PiE

The advanced 2D PiE (Panoramic Image Enhancer) filters allow to maximise 2D image rendering by automatically and selectively optimising the display of different anatomical regions and by making every acquisition detail clearer, from multiple panoramic images to dentition.

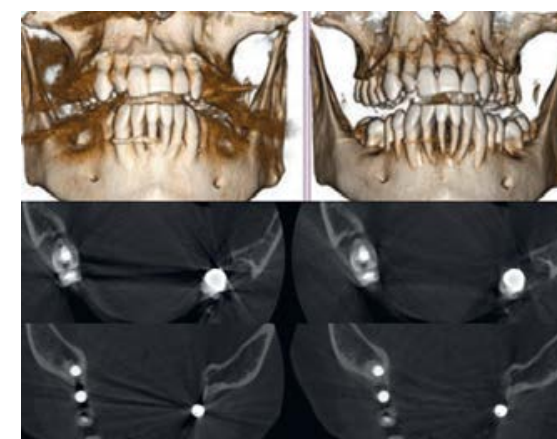

3D SMART

The intelligent 3D SMART (Streak Metal Artifacts Reduction Technology) feature reduces the presence of metal-caused artifacts in 3D volumes through a completely automatic procedure. Make your volumetric images usable at all times, also in the presence of implants and amalgam restorations.

Hyperion X9 pro, full sharing.

An innovative, easier and more efficient concept of work flow. A platform that perfectly suits your working method.

Hyperion X9 pro offers you an innovative, efficient and reliable work experience. A universe of opportunities in diagnosing and examinations sharing. The machine interfaces perfectly with advanced patient management and storage systems, thanks to its DICOM 3.0 certified compatibility. It also makes it possible to carry out remote support operations, provided an Internet connection is available, for maintenance, troubleshooting and updates, thereby minimising downtime and maximising operational efficiency and effectiveness.

Be connected.

- iRYS Viewer*
- DICOM compatibility
- Remote support

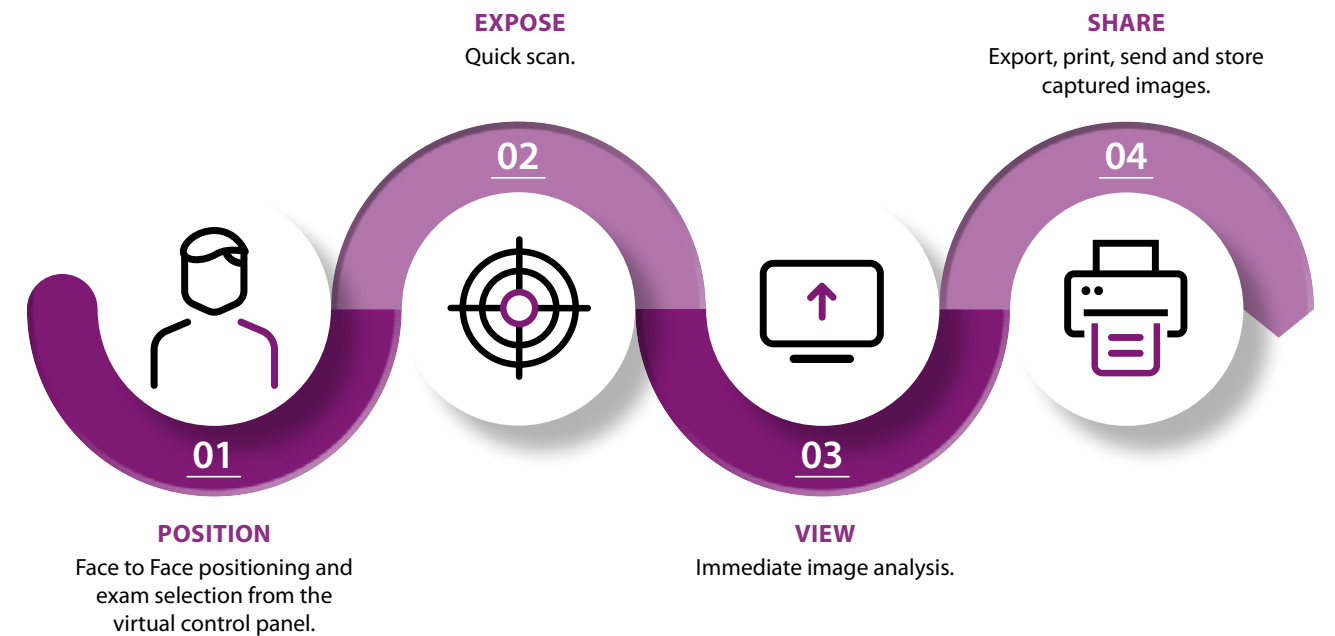

EASY WORK

Improve the quality of the clinical service, offering an answer to the problem in real time by uninterruptedly monitoring the patient's state of health during the treatment. Flowing work results in more serene patients.

FULL CONNECTIVITY

iRYS features ensure the DICOM network connection and allow to print, archive and retrieve images and to interface with booking lists.

PLUG&PLAY

Apps available for iPad*: remote control and image display, for quick and light diagnostics. Image preparation, acquisition and sharing are within reach.

REMOTE ASSISTANCE

Software updates, troubleshooting and device diagnostics. Remote maintenance allows for timely interventions without downtimes.

* must not be used for primary diagnosis.

Technical specifications.

3D IMAGES	FOV 10x8 VERSION	FOV 13x16 VERSION
Detector technology	Amorphous silicon - CsI with direct deposition	
Dynamic range	16 bit (65,535 grey levels)	
Typical scan time	14.4 s	
Rotation	360°/180°	
Image voxel size	Minimum 75 µm	Minimum 68 µm
Available FOV sizes (Øxh)	6x6 - 8x6 - 8x8 - 10x6 - 10x8	6x6 - 8x6 - 8x8 - 10x6 - 10x8 10x10 - 13x8 - 13x10 - 13x16 4x4 - 7x6 (eXtended Functionality)
Typical image size	495 MB	820 MB
Minimum scan time	6.4 s	3.6 s
Typical X-ray exposure time	1.6 s (Low-dose QuikScan) - 8.0 s (SuperHD Mode)	
Patient alignment	Servo-assisted: Scout View method	
Image format	Exclusive iRYS and DICOM 3.0 software	
Minimum render times for CB3D data	15 s on average	On average, real-time for FOV XF 4x4 QuickScan

2D IMAGES	PANORAMIC X RAY	CEPHALOMETRY
Detector technology	CMOS	
Pixel size	100 µm	
Dynamic range	14 bit (16,383 grey levels)	
Signal to noise ratio	Minimum 74dB – Typical 86dB	
Detector height	148 mm	223 mm
Image pixel matrix	max: 1470 x 2562	max: 2155 x 2935
Maximum image file size	8 MB (single image)	14 MB
Typical scan time	6 s – 12.3 s	3.3 s - 9 s
Theoretical image resolution	PAN: 6.3 (pixel pitch of 80µm) BITEWING: 7.5 lp/mm (pixel pitch of 70µm)	CEPH: 5.6 (pixel 90 µm)
Image format	TIFF 16 bit, DICOM	
Patient alignment	Servo-assisted: 4 laser guides	

X-RAY GENERATOR	
Generator type	Constant potential (DC)
Frequency	100 - 180 kHz
X-ray emission type	Continuous or Pulsed
Anode voltage	2D: 60 – 85 kV CB3D: 90 kV (Pulsed Mode)
Anode current	2 – 16 mA
Exposure time	1 s – 18 s
Focal spot	0.5 mm (IEC 60336)
Exposure control	Automatic. Morphology Recognition Technology (MRT)
Compensation of spine absorption	Automatic (modularity of X-ray beam kV)
mA and kV configuration	Modulated in real time during X-ray exposure, automatically or manually selectable in discrete increments.
Maximum continuous anode input power	42W (1:20 at 85kV/10mA)
Inherent filtration	2D: >2.5 mm Al eq. (at 85 kV) 3D: 6.5 mm Al eq. (at 90 kV)
Integrated X-ray shielding behind receptor	In compliance with IEC60601-1-3

DIMENSIONS	PAN AND CB3D	WITH TELERADIOGRAPHIC ARM
Minimum available work space requirement (L x D)	1390 x 1140 mm	1390 x 1800 mm
Package dimensions (HxLxD)	1515 x 1750 x 670 mm (basic machine); 360 x 530 x 1030 mm (telerradiographic arm)	
2-speed motorized column, adjustable height	1660 - 2450 mm	
Weight	155 Kg – 342 lbs	175 Kg – 386 lbs
Notes	Wall or floor support, free standing base available. Accessible for patients on wheelchair	

POWER SUPPLY	AUTOMATIC ADAPTATION OF VOLTAGE AND FREQUENCY
Voltage Frequency	115 - 240 Vac, ± 10% single phase 50 / 60 Hz ± 2 Hz
Maximum current temporary peak absorption	20A at 115V, 12A at 240V
Current absorption in standby mode	25 Watt

CONNECTIVITY	
Connections	LAN / Ethernet
Software	MyRay iRYS (SYstem for Radiographic imaging) and App iPad
Supported protocols	DICOM 3.0, TWAIN, VDDS
DICOM nodes	IHE- compliant (Print; Storage Commitment; WorkList MPPS; Query Retrieve)

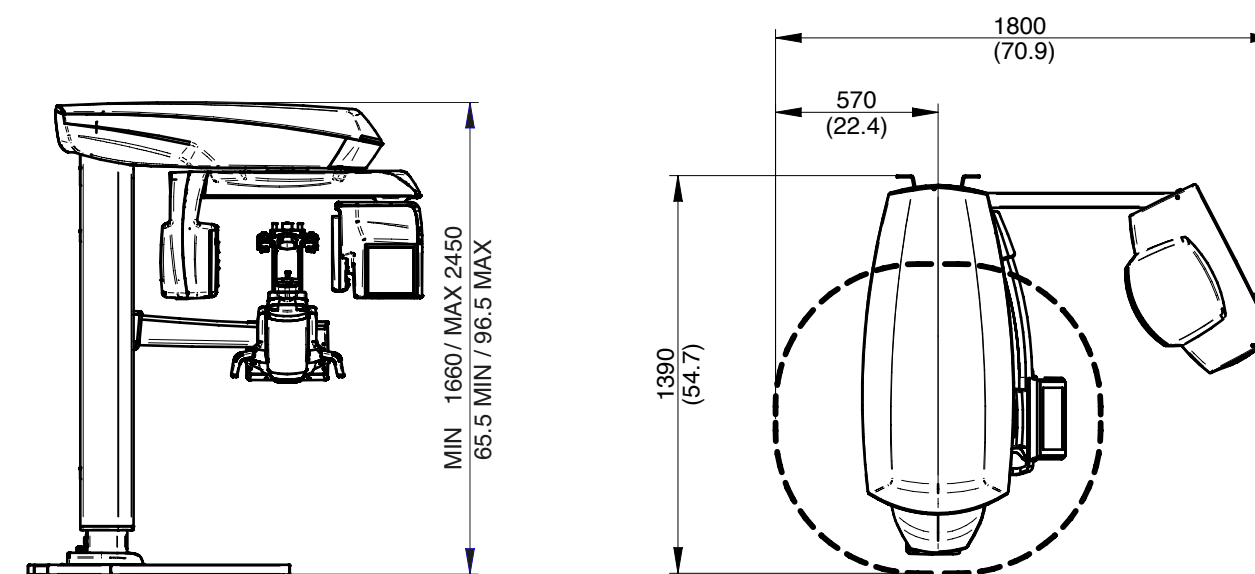

dimensions in millimetres (dimensions in inches)

MyRay, just right for you.

Leading European company for a full range of dental imaging solutions. For all dental practices.



RXDC
X-ray unit with HyperSphere technology.



RXDC
X-ray unit with eXTend technology.



RXDC
High frequency X-ray unit.



iRYS and iRYS MOBILE
Powerful imaging software.



X-pod
Portable imaging system.



Zen-X
Direct USB HD intraoral sensor.



Hy-Scan
Phosphor Plate scanner.



C-U2
HD Intraoral camera.



Hyperion X9 pro (13 x 16)
Professional 3-in-1 Full-Touch Imaging System.



Hyperion X9 (11 x 13)
3-in-1 Imaging System.



Hyperion X5 (10 x 10)
2-in-1 suspended Imaging System.



Hyperion X9 pro
Compact and professional Full-Touch MultiPAN and CEPH Imaging System.



Hyperion X9
Compact full HD PAN and CEPH Imaging System.



Hyperion X5
Suspended MultiPAN Imaging System.